

RUA 5 (V5-02)
 ESC. 1:100
 OBS: CONTE TRANSMISSÃO APRESENTADA REPRESENTA APENAS UM ROTEIRO A CALDA DE RUA, EXTENSÃO QUE INVADE DE VAS PREEXISTENTE ERROU VINCULADO.

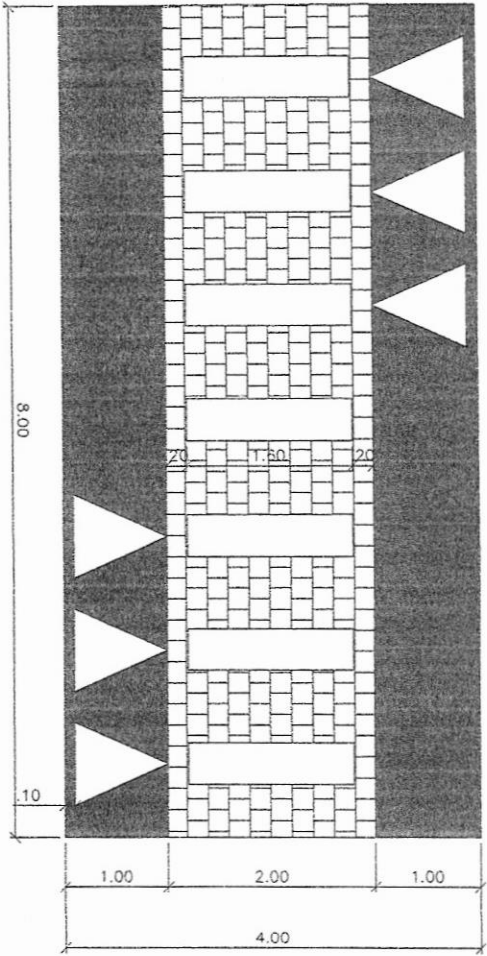

PROJETO: Rua 5 (V5-01) e Rua 5 (V5-02)
 CONTE: Projeto de requalificação de ruas e passagens - Bateria Alto Alegre - Salvador
 GOINTE: GOINTE DE VAS
 ARQUITETA: Arquiteia
 DATA: 09/12
 FOLHA: 09/12

DETALHAMENTO FAIXA ELEVADA
ESCALA: 1:25



DETALHAMENTO DA PINTURA
ESCALA: 1:25

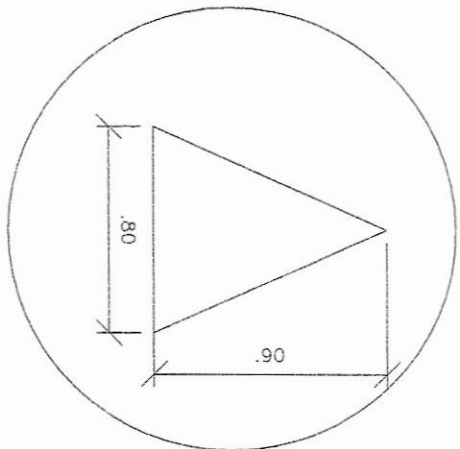

VISTA TRANSVERSAL
ESCALA: 1:10



Assinatura do Engenheiro Responsável

[Handwritten signature]

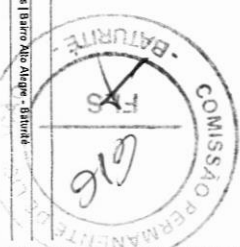

Projeto de requalificação de ruas e praças | Bairro Alto Alque - Itaboraí

COMISSÃO PERMANENTE DE BATURITÉ

Assinatura

DETA.

PRANCHA: 01/02		ASSUNTO: PAVIMENTAÇÃO EM RUAS DO BAIRRO PUTU	
DATA: 11/10/2021	ÁREA TOTAL DO TRECHO: 754,00 m	PERÍMETRO DO TRECHO: 314,00 m	
CLIENTE: PREFEITURA MUNICIPAL DE BATURITÉ			
ENDEREÇO DO IMÓVEL: BAIRRO DO PUTU			
RESPONSÁVEL TÉCNICO: DIEGO DE BRITO		ESC.: 1:375	CE
DESENHISTA: LILIANA SOUSA		ART VINCULADA:	

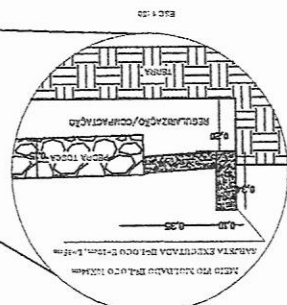
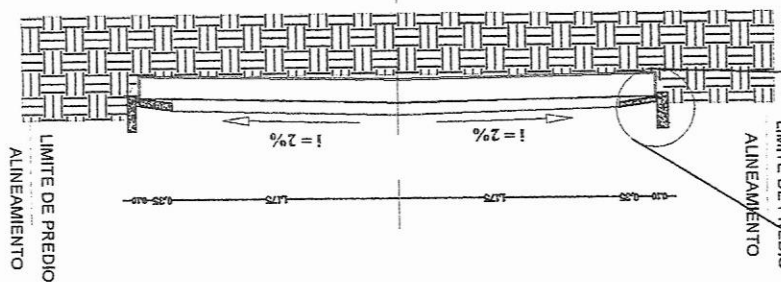

EXPOSIÇÃO DO CALÇAMENTO

TRECHOS	ESTACAS	ADICIONAL	COMPRIMENTO (M)	ÁREA DE AÇO	ÁREA DE CALÇAMENTO (M²)	ÁREA DE LANTAS DE QUANTIDADE DE
TRECHO 1	7	10,75	489,92	309,00	30,50	
TRECHO 2	4	6,97	282,65	219,00	173,94	
TRECHO 3	5	19,94	113,94	370,31	279,00	277,22
TOTAIS			351,66	1.142,90	861,00	702,22

QUADRO DE ÁREAS

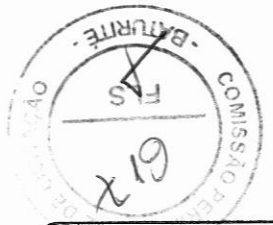
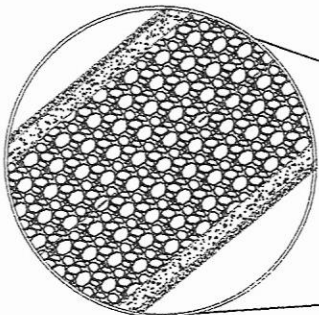
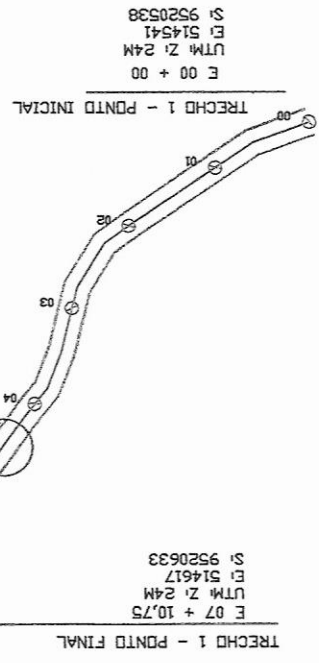

DETALHAMENTO

ESTAQUEAMENTO DO TRECHO 1

ESTAQUAMENTO DO TRECHO 2



TRECHO 2 - PONTO INICIAL

E 00 + 00
UTM: Z: 24M
E: 514620
S: 9520626

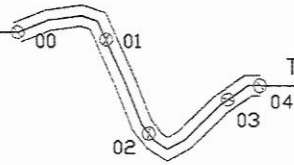

TRECHO 2 - PONTO FINAL

E 04 + 6,97
UTM: Z: 24M
E: 514664
S: 9520616

ESTAQUAMENTO DO TRECHO 3

TRECHO 3 - PONTO INICIAL

E 00 + 00
UTM: Z: 24M
E: 514664
S: 9520616

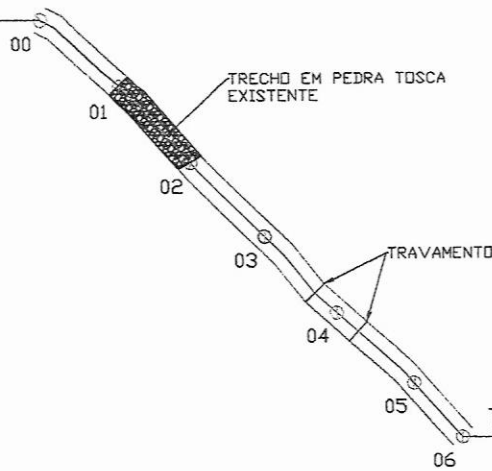

TRECHO 3 - PONTO FINAL

E 05 + 13,94
UTM: Z: 24M
E: 514746
S: 9520535

Handwritten signature and stamp.

QUADRO DE ÁREAS

ESTAQUEAMENTO						
TRECHOS	ESTACAS	ADICIONAL	COMPRIMENTO (M)	ÁREA DE AÇÃO	ÁREA DE CALÇAMENTO (m ²)	QUANTIDADE DE MEIO FIO (M)
TRECHO 1	7	10,75	150,75	435,94	309,00	301,50
TRECHO 2	4	6,97	86,97	282,65	213,00	173,94
TRECHO 3	5	13,94	113,94	370,31	279,00	227,88
TOTALS			351,66	1.142,50	801,00	703,32

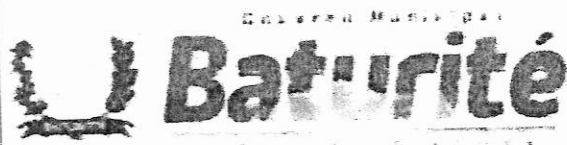

ASSUNTO: PAVIMENTAÇÃO NAS RUAS DO BAIRRO PUTIÚ		PRANCHA: 02/02
QUADRO DE ÁREA:		
ÁREA TOTAL DO TRECHO 2 e 3: 495,00 m ²	PERÍMETRO DO TRECHO: 401,82m	DATA: 08/12/2023
CLIENTE: PREFEITURA MUNICIPAL DE BATURITÉ		
ENDEREÇO DO IMÓVEL: BAIRRO DO PUTIÚ		
RESPONSÁVEL TÉCNICO: ANTÔNIO CLAUDINEY	ESC.: 1:175	ART VINCULADA.: CE
		DESENHISTA: LILIANA SOUSA

ESTAQUEAMENTO DO TRECHO 1

DETALHAMENTO

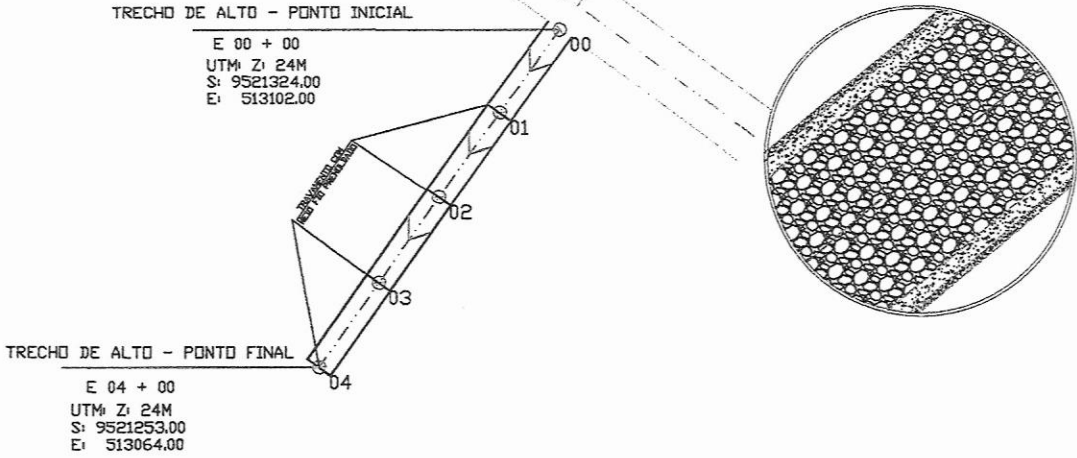

TRECHOS	ESTACAS	ADICIONAL	COMPONENTO (M)	ÁREA DE AÇÃO	ÁREA DE CALÇAMENTO (m2)	QUANTIDADE DE MEIO FIO (M)	TRAVAMENTO (M)
ALTO	4	0,00	80,00	440,00	383,00	160,00	22,00

EXPOSIÇÃO DO CALÇAMENTO

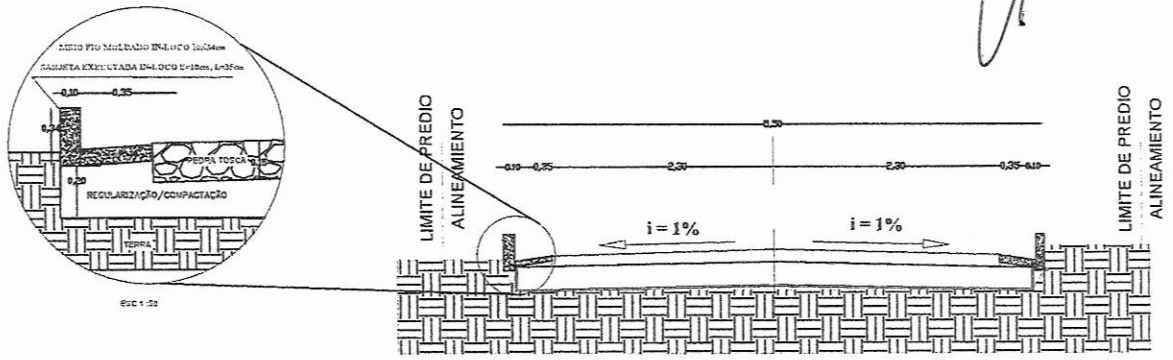

<p>Baturité Ceará</p>	ASSUNTO: PAVIMENTAÇÃO EM NOVA RUA NO CENTRO			PRANCHA: 01/01
	QUADRO DE ÁREA DO TRECHO 1:			
	ÁREA TOTAL DO TRECHO: 754,00 m	PERÍMETRO DO TRECHO: 314,00 m		DATA: 11/12/2023
	CLIENTE: PREFEITURA MUNICIPAL DE BATURITÉ			
	ENDEREÇO DO IMÓVEL: TRAVESSACICERO SEGUNDO BAIRRO PUTIU			
RESPONSÁVEL TÉCNICO: DIEGO DE BRITO	ESC.: 1:375	ART VINCULADA.: CE	DESENHISTA: LILIANA SOUSA	

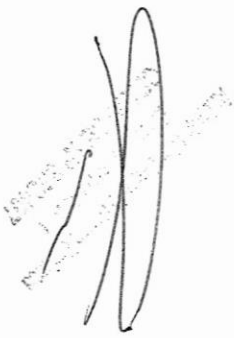
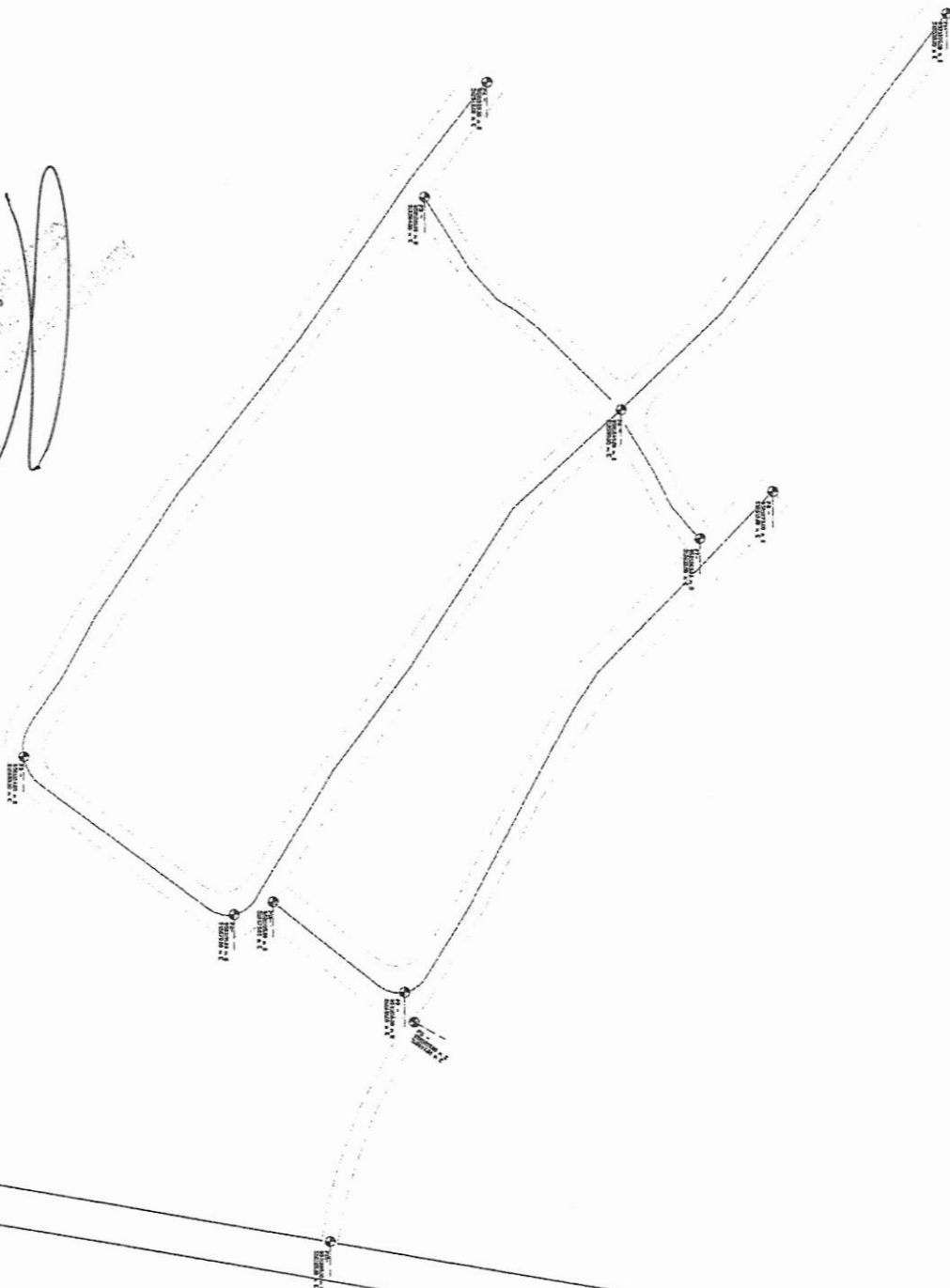

PROJETO: [unreadable]
 Arquitetura e Urbanismo | Companhia Saneamento de Curitiba
 PROJETO DE ARQUITETURA E URBANISMO
 PLANTA DE SITUAÇÃO E COORDENADAS



ESTAQUEAMENTO DO TRECHO 1 E 2

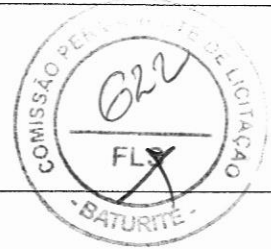

TRECHO 01 - PONTO FINAL

E 04 + 00
 UTM: Z: 24M
 S: 9522764.27
 E: 512873.11

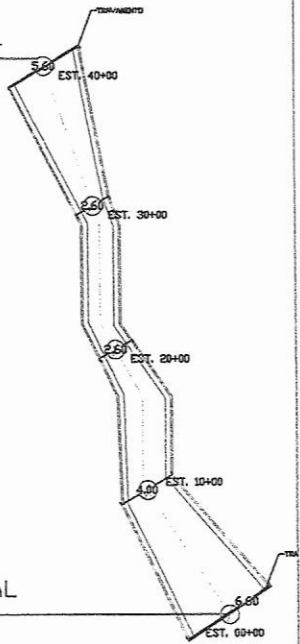

TRECHO 01 - PONTO INICIAL

E 00 + 00
 UTM: Z: 24M
 S: 9522731.65
 E: 512885.22

TRECHO 02 - PONTO FINAL

E 05 + 00
 UTM: Z: 24M
 S: 9523134.98
 E: 512779.05

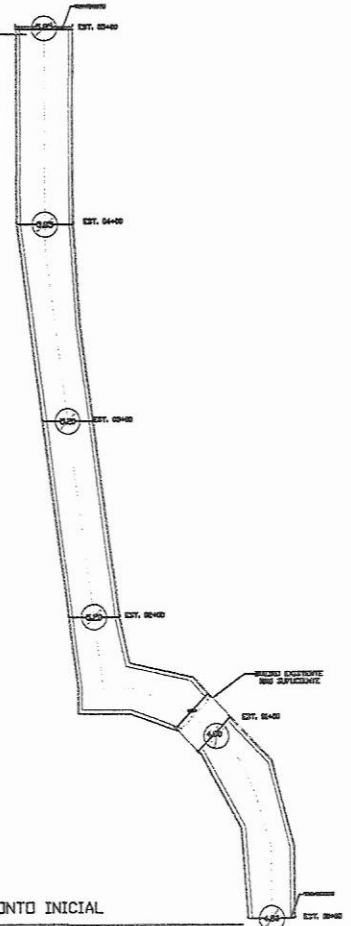

TRECHO 02 - PONTO INICIAL

E 00 + 00
 UTM: Z: 24M
 S: 9523061.19
 E: 512798.96

EXPOSIÇÃO DO CALÇAMENTO

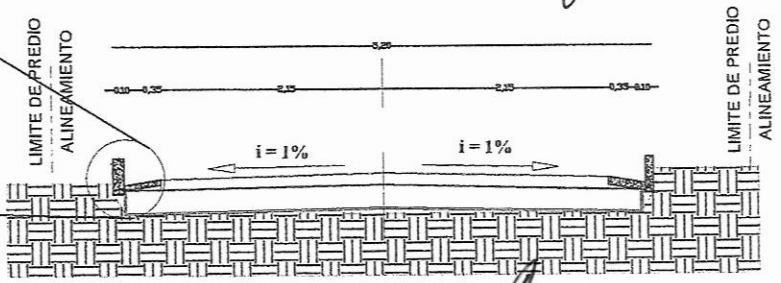
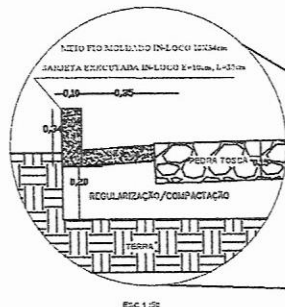

Handwritten signature and notes.

ASSUNTO: PAVIMENTAÇÃO EM RUAS DO MONDEGO

PRANCHA:

01/02

QUADRO DE ÁREA DO TRECHO 1 e 2:

ÁREA TOTAL DO TRECHO:
680,60

PERÍMETRO DO TRECHO:
140,00

DATA:
28/12/2023

CLIENTE: PREFEITURA MUNICIPAL DE BATURITÉ

ENDEREÇO DO IMÓVEL: TRAVESSACICERO SEGUNDO BAIRRO PUTIU

RESPONSÁVEL TÉCNICO:
DIEGO DE BRITO

ESC.:
espec.

ART VINCULADA.:
CE

DESENHISTA:
LILIANA SOUSA

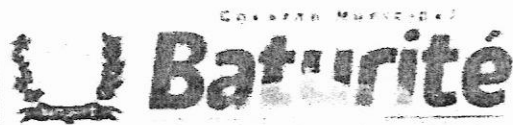

DIMENSIONAMENTO EM MILIMITRO



VISTA SUPERIOR

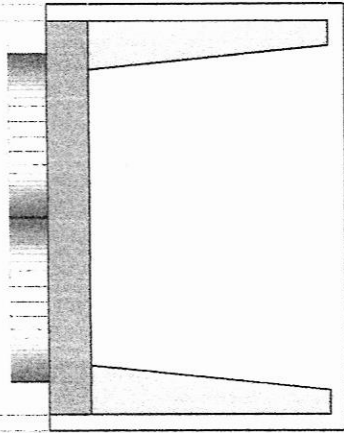

VISTA LATERAL

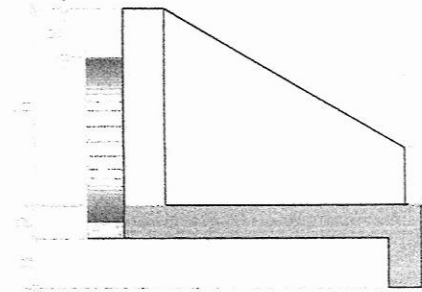

VISTA FRONTAL

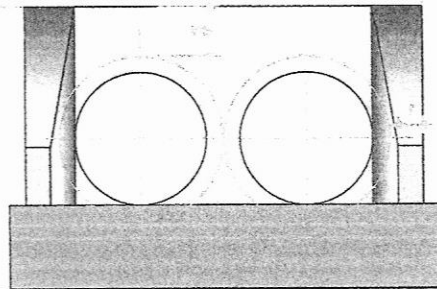

[Handwritten signature]

ESC.	BUEIRO DUPLO TUBULAR $\phi=100$													FORMAS (m ²)	CONCRETO (m ³)	CIMENTO SACO 50Kg	AREIA (m ³)	BRITA BRITA (m ³)	ÁGUA (m ³)	MADEIRA (m ³)
	a	b	c	d	e	f	g	h	k	m	n	P	L							
0°	290			35									310	11,51	3,037	14,883	2,065	2,248	0,486	0,288
5°	291			35									311	11,54	3,039	14,892	2,067	2,249	0,486	0,289
10°	294			36									315	11,64	3,044	14,917	2,070	2,253	0,487	0,291
15°	300			36									321	11,81	3,053	14,960	2,076	2,259	0,488	0,295
20°	309	30	165	37	50	20	30	142	10	22	32	22	330	12,06	3,065	15,019	2,084	2,268	0,490	0,301
25°	320			39									342	12,41	3,080	15,093	2,095	2,279	0,493	0,310
30°	335			40									358	12,89	3,099	15,184	2,107	2,293	0,496	0,322
35°	354			43									378	13,54	3,120	15,289	2,122	2,309	0,499	0,339
40°	379			46									405	14,43	3,145	15,408	2,138	2,327	0,503	0,361
45°	410			49									348	15,66	3,171	15,540	2,157	2,347	0,507	0,391

	ASSUNTO: PAVIMENTAÇÃO EM RUAS DO MONDEGO		PRANCHA: 02/02
	DETALAMENTO DE DRENAGEM		
	ÁREA TOTAL DO TRECHO: 15,84 M2	PERIMETRO DO TRECHO: 140,00	DATA: 28/12/2023
	CLIENTE: PREFEITURA MUNICIPAL DE BATURITÉ		
	ENDEREÇO DO IMÓVEL: TRAVESSACICERO SEGUNDO BAIRRO PUTIU		
RESPONSÁVEL TÉCNICO: DIEGO DE BRITO	ESC.: espec.	ART VINCULADA.: CE	DESENHISTA: LILIANA SOUSA

01 PLANTA SITUÇÃO - PAVIMENTAÇÃO ENTORNO DA ARENINHA
 ESCALA: 1/200

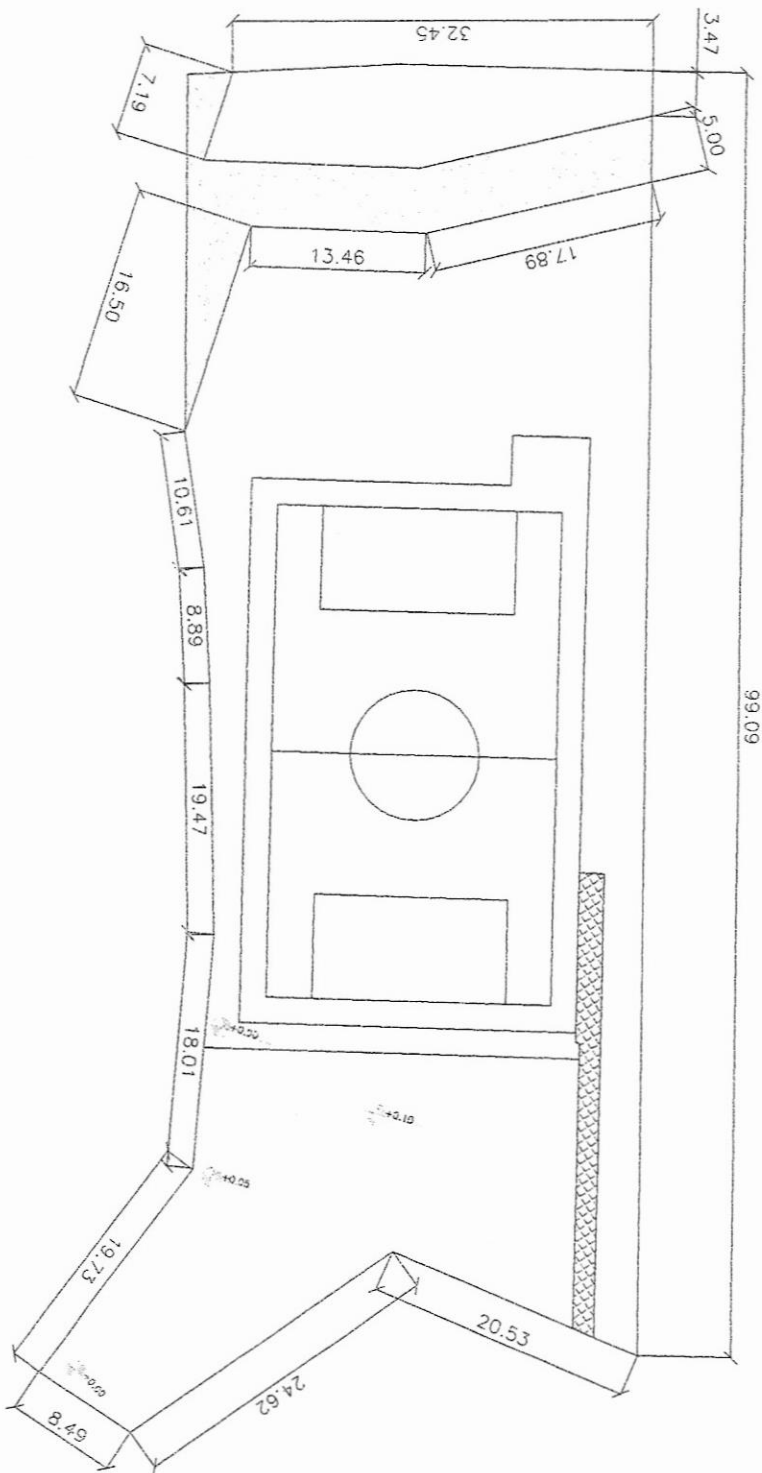

Handwritten signature and stamp



PROJETO	Projeto de pavimentação entorno da areninha Bairro Pólis - Jardim Botânico
CONTEÚDO	PLANTA DE SITUÇÃO
PROFESSOR	Arquiteta
PROFESSOR	01/06

Escala
 Vedação
 COMISSÃO PERMANENTE DE PROJETOS
 Estação de controle
 624
 01/06

02 PLANTA COORDENADAS - PAVIMENTAÇÃO ENTORNO DA ARENINHA
 ESCALA: 1:200

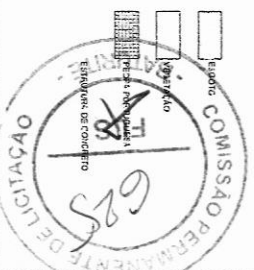
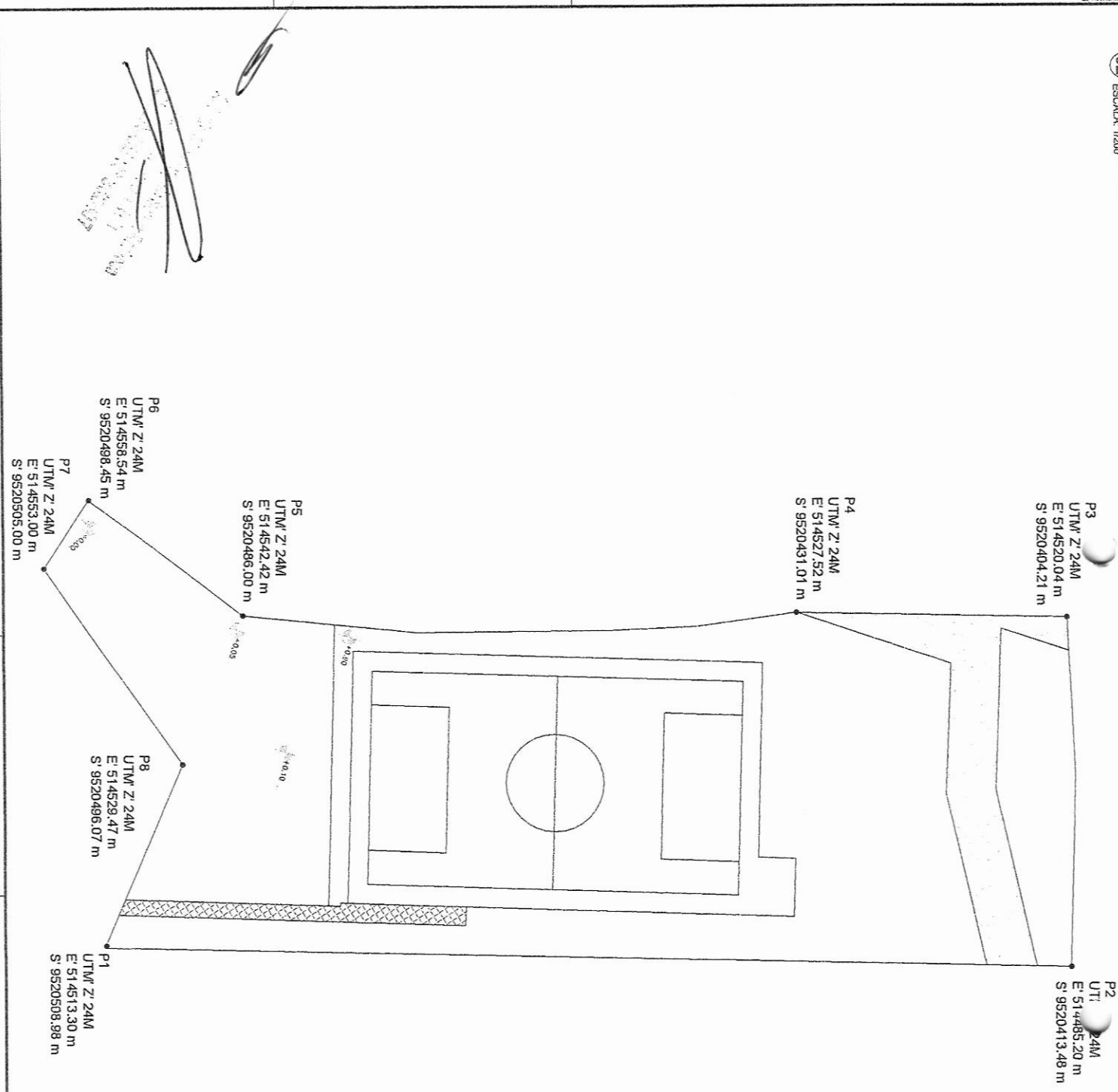

PROJ. 10	Projeto de pavimentação entorno da areninha Bairro Pulo - Guaratã
CONTEÚDO	
PLANTA DE COORDENADAS	
PROFESSOR RESPONSÁVEL	Arquiteta
PROFESSOR DE LICITAÇÃO	
DATA	02/06

TABELA DE MEDIDAS	
BAIDRAMES	6,80 m ³
PEDRA PORTUGUESA	06,12 m ²

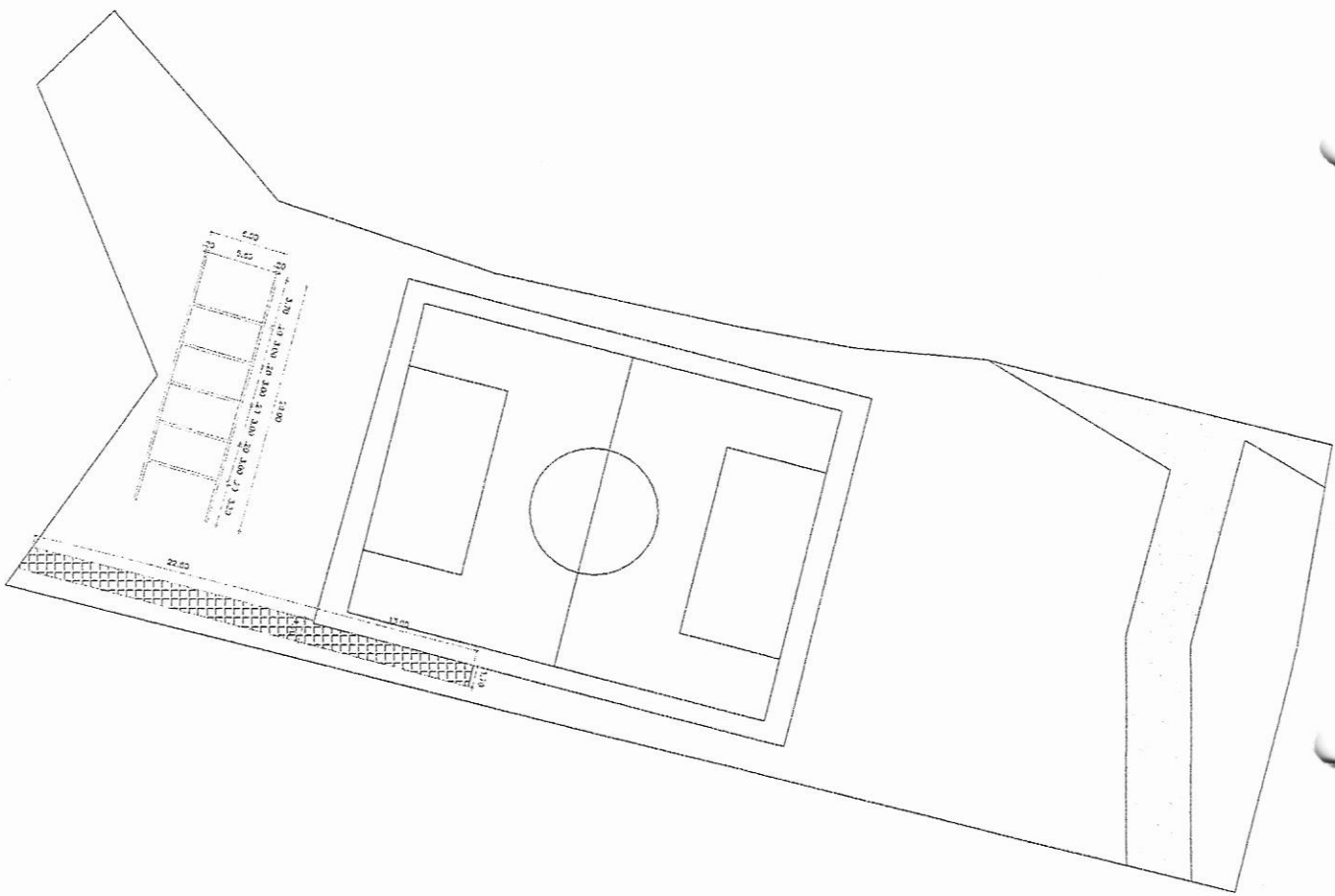

[Handwritten signature and notes]

FOLHA: 1/0
 Projeto de pavimentação entorno da areninha | Bairro Pudo - Baturite
 CONTINUA
 PLANTA DE DEMOLIÇÃO
 Arquitetura
 03/06



Planto

